

Figure 1: Business Values - overview

Outline

Contents

1	COST-Action	1
1.1	Business values in Pathology	1
1.2	Business processes in Pathology	2
2	Results of STSM Cornils & Zhou	8
2.1	STSM Zou	8
2.2	STSM Malte Cornils	11
3	Summary	13
3.1	Summary	13
3.2	Sources & Literature	13

1 The results of Working Group 1, COST-Action

1.1 Business values in Pathology

Final “products” of Pathology Department

Diagnostic process

Research

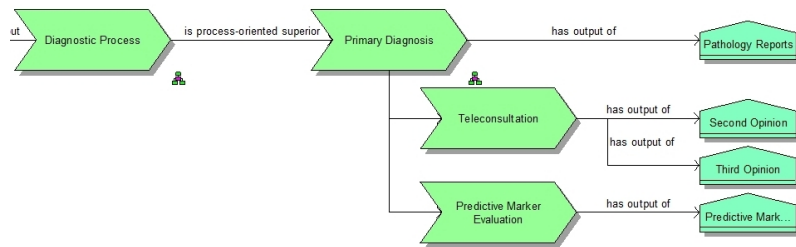

Figure 2: Business Values - detail

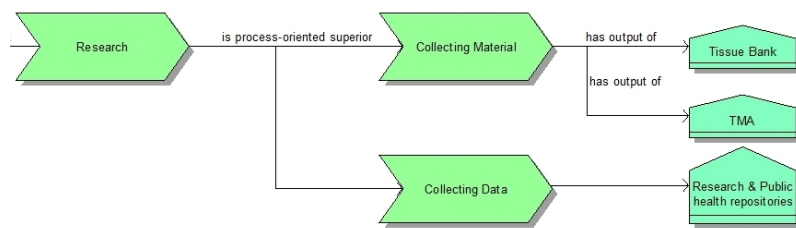

Figure 3: Business Values - detail

Education

1.2 Business processes in Pathology

Overview in BPMN

Basic business process

EPC Event-Process-Chain

- **Function or Process** - green rectangle
- **Event** as input object or output object - rhombus

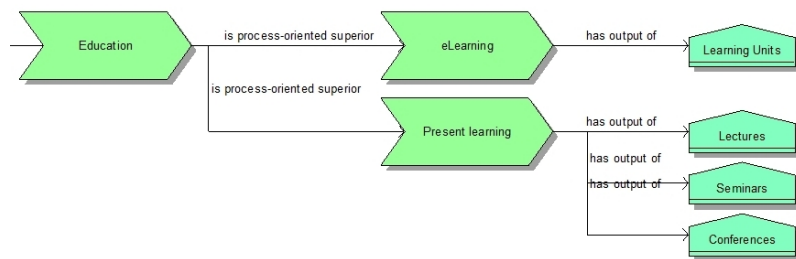

Figure 4: Business Values - detail

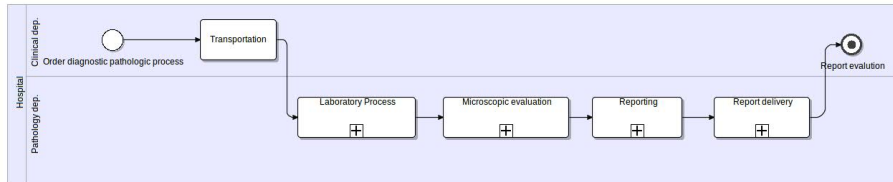

Figure 5: BPMN of an abstract view of processes

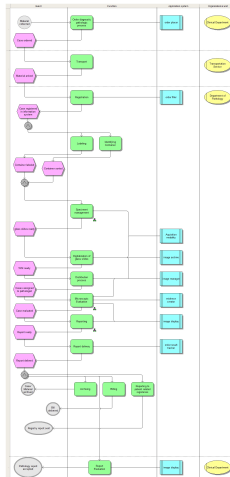

Figure 6: Overview

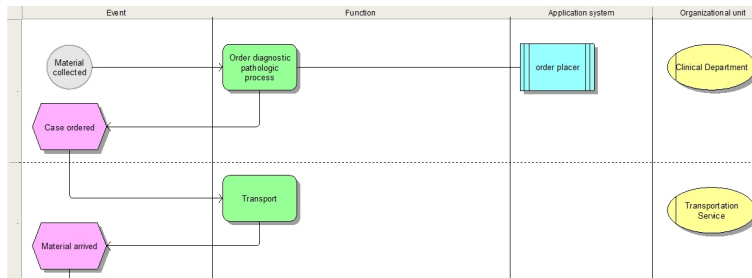

Figure 7: Clinical request & transport

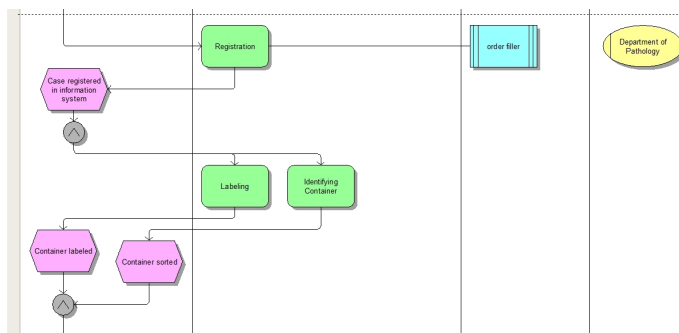

Figure 8: Labeling & sorting

- Forks & joints - circles
- Related IHE actors - blue rectangle
- Organizational unit - yellow ellipse

Basic business process - part I

Basic business process - part II

Basic business process - part III

Basic business process - part IV

Macroscopic description

Mircoscopic Evaluation

Quality Assurance

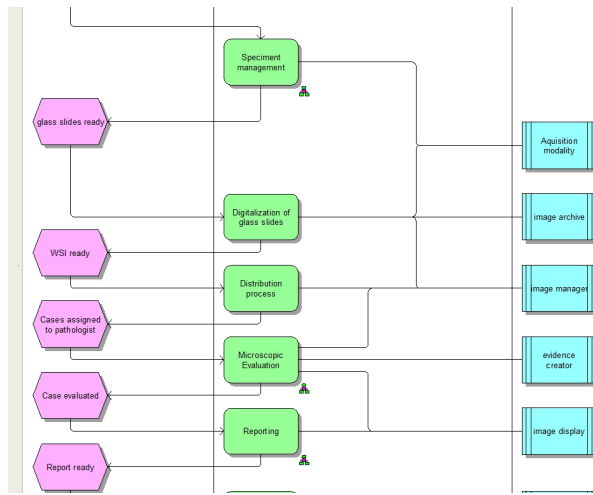

Figure 9: Laboratory & diagnostic process

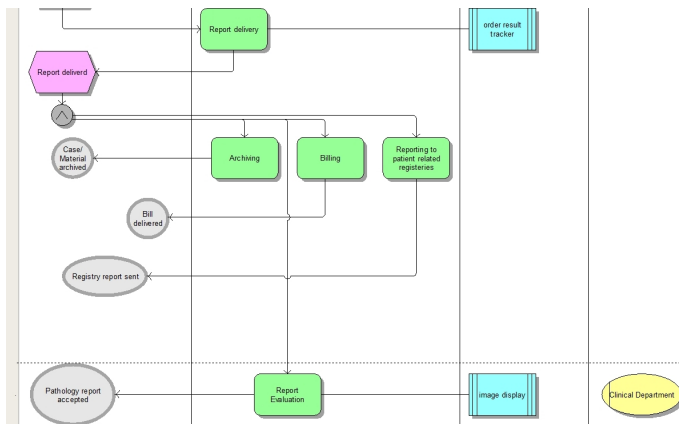

Figure 10: Report delivery

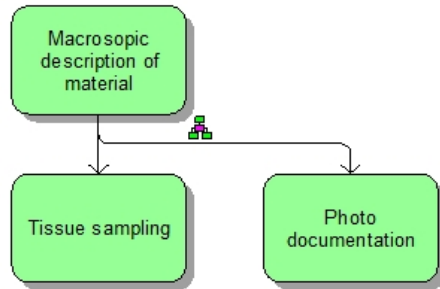

Figure 11: Function tree of macroscopic description

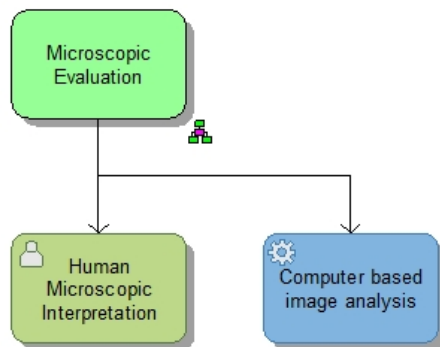

Figure 12: Function tree of process step microscopic evaluation

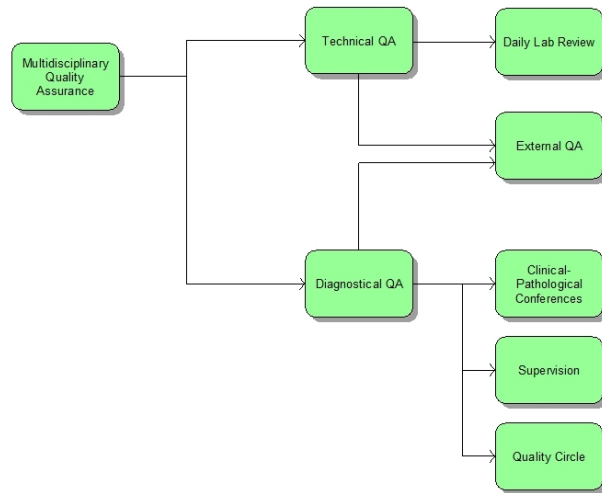

Figure 13: Function tree for quality assurance processes

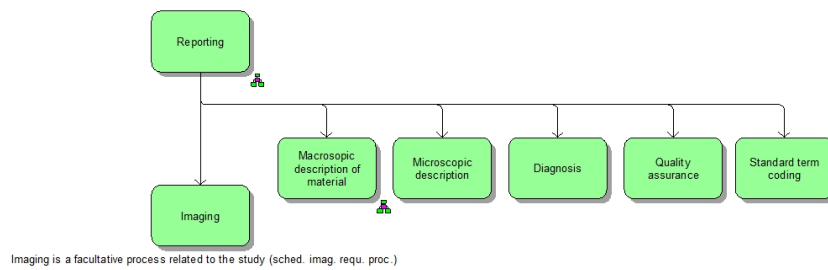

Figure 14: Reporting as function tree

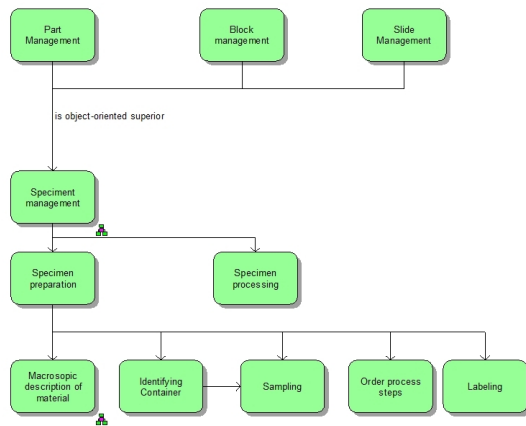

Figure 15: Complex function tree for specimen processing

Reporting processes

Speciment management

Process flow of teleconsultation

2 Results of STSM Cornils & Zhou

2.1 Comparison different notations

Notations in business modeling

- Business Process Modeling Notation - BPMN
- Event Process Chain - EPC
- UML Activity Diagram

Frozen section model

Frozen section model

Frozen section model

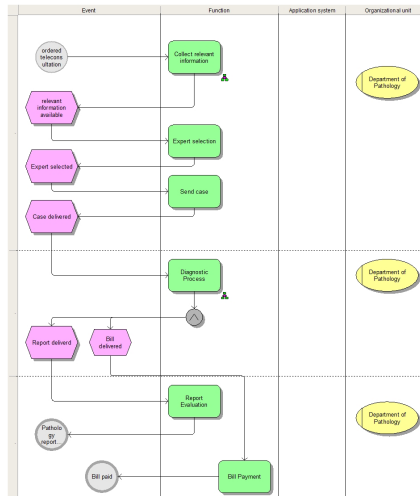

Figure 16: Teleconsultation

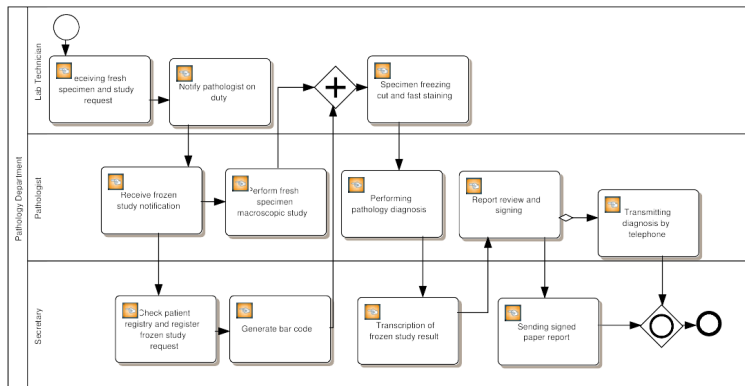

Figure 17: BPMN model for frozen sections

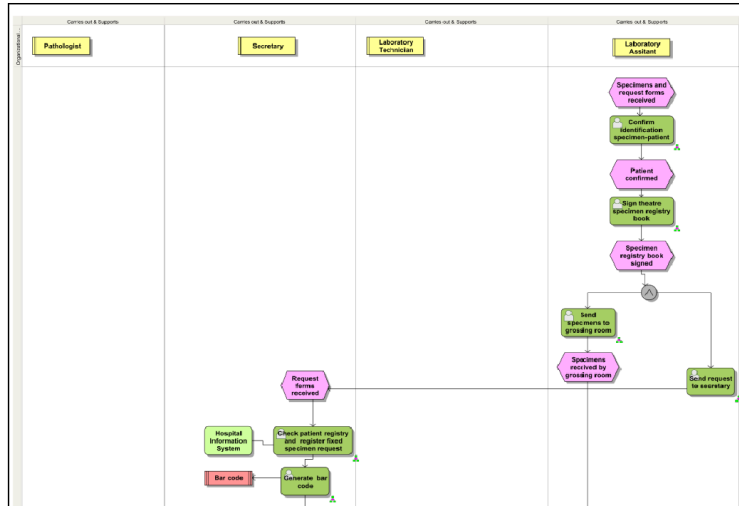

Figure 18: EPC model

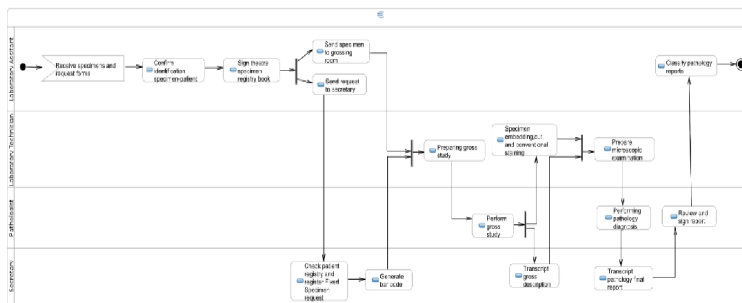

Figure 19: UML model

Results of comparison

- BPMN is the modelling notation which is clearer and more understandable to pathologists.
- EPC is harder for pathologists to read and understand. It is probably because EPC is not as popular as BPMN and UML AD, so pathologists are not so familiar with the concept of event-driven process.
- The current two pathology processes – Frozen Study and Formalin Fixed Specimen Study – are not complete in some aspects. Further work will be needed to modify the processes according to feedbacks we have gotten from the pathologists.

2.2 STSM Malte Cornils

Simulating business processes in pathology

- Business modeling simulation theory and methods
- Applicability for the medical domain of pathology
- Concrete examples of business process simulation using modeling languages and tools and a process-driven design process

Tools for simulation

- etibia simulation environment
- eClarus toolkit based on the ActiveVOS software
- Intalio stack
- jBPM - a toolkit developed for JBoss

Global process model

Formalin fixed study process

Simulation

Results

- Simulation is a very usefull tool for process evaluation
- Current tools with limited functionality
- But the the tools will better in the next future

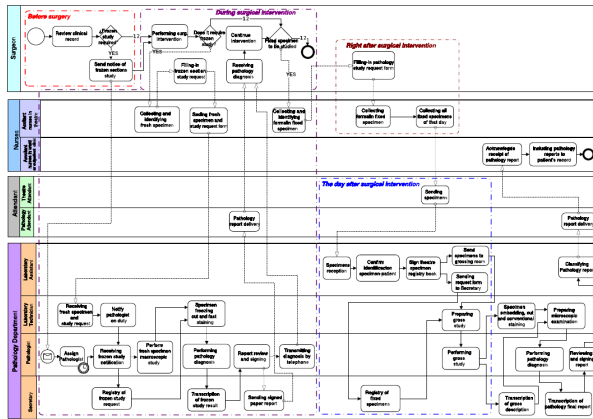

Figure 20: BPMN model by UCLM

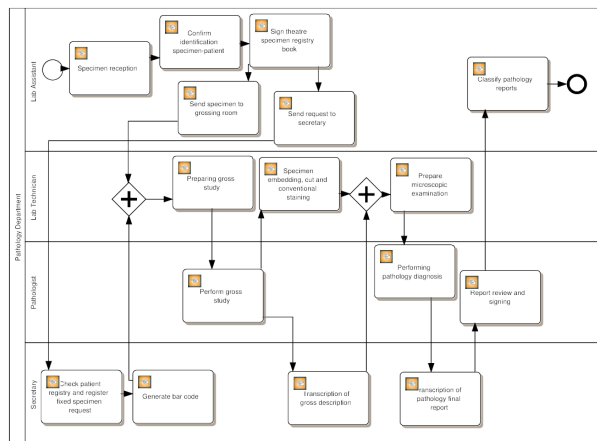

Figure 21: BPMN model

Number	Name	Exp. Time	Min. Time	Max. Time	Failure Probability
13	Receive frozen study notification		10 seconds	5 minutes	elec./manual
14	Perform specimen macroscopic study		1 minute (malignant or not?)	10 minutes (complex)	cplx: borders are clear? distances?
15	Registry of frozen study request		2 min	5 min	if pat. exists
16	Specimen freezing cut and fast staining	w/o stain: 3 5 min. fast stain: 3 5min	3 5 min. 3 5min	30 min. 3 5min	up to 10 specimen, freeze together, cut separately, 2 cryostats here
17	Performing pathology diagnosis		1 min	10 min	
18	Transcription of frozen study results		5 minutes	20 min	type yourself, or w/secretary and roundtrips

Figure 22: Time constrains

3 Summary

3.1 Summary

Summary

Now Status quo

- A general business process in pathology is described.
- The process model has a close relationship to the standards (DICOM, HL7).
- BPMN is chosen as the main modeling language

Future What should be done?

- Transformation from EPC to BPMN
- Convergence to unified process description terms related to SNOMED

3.2 Sources & Literature

Sources & Literature

- BPMN: www.bpmn.org, de.wikipedia.org
- UML
 - Kecher C. UML 2.0: Das umfassende Handbuch ; [aktuell zum UML-Standard 2.0, alle Diagramme und Notationselemente, Praxisbeispiele in C und Java]. 2., aktualisierte und erw. Aufl., 1. Nachdr. Bonn: Galileo Press; 2007.
 - Zuser W, Grechenig T, Köhle M. Software Engineering mit UML und dem Unified Process. 2., überarb. Aufl. München: Pearson Studium; 2004.
 - Heumann, J. Introduction to business modeling using the Unified Modeling Language (UML) IBM Developer works; 2003.

Sources & Literature

- ARIS
 - Klückmann, Jörg. ARIS Expert Paper: Auf dem Weg zur SOA; 2006. 2007 Jun 04 (cited 2009 Mar 8).
 - Lehmann FR. Integrierte Prozessmodellierung mit ARIS. 1. Aufl. Heidelberg: dpunkt Verl.; 2008.
 - Oracle. Methods - Oracle Business Process Analysis Suite 10.1.3; 30.08.2006. 2006 Aug 30 (cited 2009 Mar 8).

Reference images

- www.pathologie.uni-wuerzburg.de/geschichte
- www.verein-dominik.org/beateklein/05jan06.htm
- jkjpathology.com/doctors/reports.htm

Thank you for your attention!

Any questions?

Contact

- Prof. Dr. Thomas Schrader
- thomas.schrader@computer.org